

SET LAUFEN PRO

Shower tray MARBOND rectangular

21095.1 / 21095.7

21295.4 / 21295.5

21295.1 / 21095.2

21095.8 / 21195.3



TECHNICAL DATA

Order no.	21095.1, 21095.7 / 1000 mm 21295.4, 21295.5 / 1100 mm 21295.1, 21095.2, 21095.8, 21195.3 / 1200 mm	Mounting acc. excl.	Installation frame, adjustable height between 85-160 mm, order no. 29844.1 Antinoise set for the frame installation to fulfil DIN 4109 and SIA 181, order no. 29898.8 3-D sealing tape: Sealing set 3,0 m, for sealed sides \leq 3 m, includes 1 sealing tape (width 120 mm, length 3 m), 3-D inside corner for sealing (1 piece) and 2x 3 m antinoise tape (width 30 mm), order no. 29564.2 Additional sealing set 2,0 m, for sealed sides \geq 3 m, order no. 29564.7 3-D sealing corners: Inside corner, 1 piece, order no. 29564.3 Outside corner for floor-even installation, set 3 parts, order no. 29564.4 Dispersion sealing composition, tube 500 ml, order no. 29564.5 Noise control band, order no. 29555.1
Certified to	EN 14257, EN 251	Otherwise	For customised Marbond shower trays order no. 21295.0 please use the order form.
Dimensions	see table below	Colours	000 – White matt structured, 077 – Light grey matt structured, 078 – Anthracite matt structured
Depth	see table below		
Specification	Rectangular shower tray made of Marbond (Gel Coat surface matt, with structure) with Antislip, Class C (DIN 51097) Removable siphon cover, stainless steel For floor-even installation or on floor installation		
Weight	21095.1 – 35,0 kg / 21095.7 – 37,0 kg 21295.4 – 37,0 kg / 21295.5 – 43,0 kg 21295.1 – 36,0 kg / 21095.2 – 45,0 kg 21095.8 – 44,0 kg / 21195.3 – 51,0 kg		
Mounting acc. excl.	Mounting box type DN 50, height 100 mm incl. waste, \varnothing 90 mm without cover (pre-assembled) left, order no. 29004.3, right, order no. 29004.4 Mounting box type DN 40, height 75 mm incl. waste, \varnothing 90 mm without cover (pre-assembled) left, order no. 29003.3, right, order no. 29003.4 Waste DN 50, \varnothing 90 mm without cover, order no. 29512.7 Mounting box type DN 50, height 100 mm, left, order no. 29004.1, right, order no. 29004.2 Mounting box type DN 40, height 75 mm, left, order no. 29003.1, right, order no. 29003.2		

TECHNICAL DRAWINGS / S 1 : 20

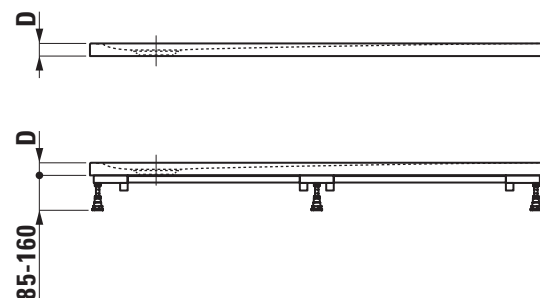
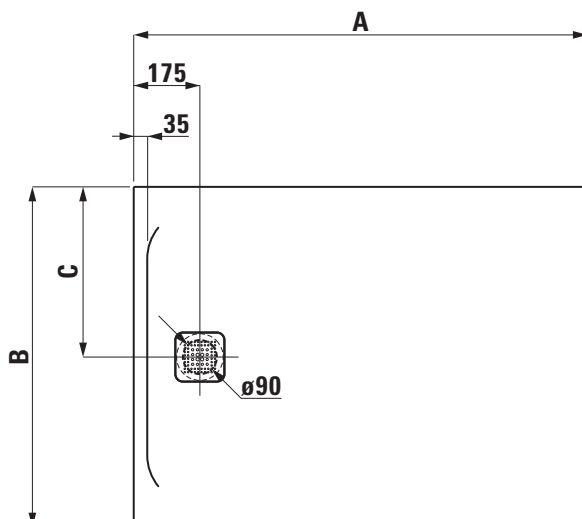

Order no.	A / mm	B / mm	C / mm	D / mm
21095.1	1000	800	400	33
21095.7	1000	900	450	33
21295.4	1100	800	400	33
21295.5	1100	900	450	33
21295.1	1200	700	350	38
21095.2	1200	800	400	33
21095.8	1200	900	450	33
21195.3	1200	1000	500	33